



Bastrop County

REQUESTS FOR BIDS

Bid Reference Number: RFB 26BCP05B

Project Title: TxDOT Recommend Erosion Control and Repairs Project - Precinct 3

Bid Closing Date: 2 :00 P.M. (CST), June 18, 2026

Table of Contents.....Page 2

Request for Bids

(1) Introduction.....Page 3
(2) Definitions.....Page 3
(3) General Information.....Page 4
(4) RFB Withdrawals and/or Amendments.....Page 6
(5) Bid Submittal Requirements.....Page 6
(6) Bid Evaluation and Contract Award.....Page 7

Appendix A – Scope of Services

(1) Project Title.....Page 9
(2) Scope of Services Contact.....Page 9
(3) Bid Evaluation Factors.....Page 9
(4) Key Events Schedule.....Page 9
(5) Scope of Services.....Page 9
Project Site Maps, Photos, TXDOT Standard Sheets.....Page 11
BID SHEET.....Page 20

Appendix B – Bid

Bid Verification.....Page 21

I Contract Award Information

(1) Term of Contract.....Page 22
(2) Federal, State and/or Local Identification Information.....Page 22

II Contract Terms and Conditions

(1) Standard Terms and Conditions.....Page 22

RFB Acknowledgement Form.....Page 28

Appendix C – Form CIQ.....Page 29

Appendix D – Certificate of Interested Parties (Form 1295).....Page 31

Appendix E – HB 89 Verification Form.....Page 34

Appendix F – Bastrop County Section 3 Resolution.....Page 35

Bastrop County

Request for Bids

1. Introduction

- A. Project Overview: Bastrop County is requesting Bids with the intent of awarding a contract for the purchase of goods and services contained in Appendix A – Scope of Services.
- B. RFB Questions:
- i. RFB Clarifications: All questions related to requirements, processes or scope of work for this RFB should be submitted in writing to the Purchasing Agent identified in section 2 below. The County is the final judge of the meaning of any word(s), sentences, paragraphs or other parts of the solicitation documents. Bidders are encouraged to seek clarification, before submitting a Bid, of any portion of the Bid documents that appears to be ambiguous, unclear, inconsistent, or otherwise in error. Clarifications will be in writing.
 - ii. Replies: Responses to inquiries which directly affect an interpretation or effect a change to this RFB will be issued in writing by addendum and will be uploaded to the Bastrop County website (<http://www.co.bastrop.tx.us/page/pur.bids>). All such addenda issued by County prior to the submittal deadline shall be considered part of the RFB. The County shall not be bound by any reply to an inquiry unless such reply is made by such formal written addendum.
 - iii. Acknowledgement of Addenda: The Bidder must acknowledge all addenda by signing and returning such document(s) or by initialing appropriate area of the Bid.
- C. Notification of Errors or Omissions: Bidders shall promptly notify the County of any omissions, ambiguity, inconsistency or error that they may discover upon examination of this RFB. The County shall not be responsible or liable for any errors and/or misrepresentation that result from the solicitations which are inadvertently incomplete, ambiguous, inconsistent or obviously erroneous.
- D. Conflict of Interest Questionnaire (Form CIQ): A person or business, and their agents, who seek to contract or enter into an agreement with the County, are required by Texas Local Government Code, Chapter 176, to file a conflict of interest questionnaire (FORM CIQ) which is found in Appendix C.
- E. Certificate of Interested Parties (1295 Form): A person or business, and their agents, who seek to contract or enter into an agreement with the County, are required by Texas Local Government Code Chapter 2252, Subtitle F, Title 10, Section 2252.908, to file a disclosure of interested parties with the Texas Ethics Commission (https://www.ethics.state.tx.us/whatsnew/elf_info_form1295.htm). A sample form and instruction sheet can be found in Appendix D.
- F. House Bill 89 Verification Form: A person or business, and their agents, who seek to contract or enter into an agreement with the County, are required by Texas Local Government Code Chapter 2270 Section 1, Subtitle F, Title 10, Section 2270.001 to submit a verification form to the County. This Chapter reads “Prohibition on Contracts with Companies Boycotting Israel”. This form is found in Appendix E.
- G. Texas Senate Bill 13 (Sb 13): Energy Company Boycotts: If contractor is required to make a verification pursuant to section 2274.002 of the Texas Government Code, contractor verifies that it does not boycott energy companies and will not boycott energy companies during the term of the contract. If the contractor does not make that verification, the contractor must indicate in its response and state why the certification is not required.

- H. Texas Senate Bill 19 (Sb 19): Firearm Entities And Trade Associations Discrimination: If contractor is required to make a verification pursuant to Section 2274.002 of the Texas Government Code, contractor verifies that it (1) does not have a practice, policy, guidance, or directive that discriminates against a firearm entity or firearm trade association and (2) will not discriminate during the term of the contract against a firearm entity or firearm trade association. If the contractor does not make that verification, the contractor must so indicate in its response and state why the verification is not required.
- I. 2 CFR 200: In accordance with PART 200 of the UNIFORM ADMINISTRATIVE REQUIREMENTS, COST PRINCIPLES, AND AUDIT REQUIREMENTS FOR FEDERAL AWARDS, Bastrop County follows the procurement standards in the Code of Federal Regulations of 2 CFR 200.317 – 2CFR 200.327 and Appendix II to Part 200 for procurement actions to be funded with Federal funds.

2. Definitions

Bid: The signed and executed submittal of the entirety of Appendix B – Bid.

Bidder: The Bidder and the Bidder’s designated contact signing the first page of the Bid.

County of Bastrop (“County”): The County of Bastrop, Texas.

Bastrop County Purchasing Office: The Bastrop County Purchasing Office is located at 1041 Lovers Lane, Bastrop County 78602. PH: (512) 581-7110; Fax: (512) 581-4228.

Project: The name is identified on the cover sheet and first page of Appendix A – Scope of Services.

Purchasing Agent: Bastrop County Purchasing Agent is Leon Scaife:

Phone: (512) 581-7110

E-Mail: leon.scaife@co.bastrop.tx.us

Request for Bids (RFB): The entirety of this document, including all Appendices and Addenda.

Scope of Services: The entirety of Appendix A – Scope of Services.

3. General Information

- A. Tax Exempt Status: County purchases are exempt from State Sales Tax and Federal Excise Tax. Do not include tax in the Bid. County will furnish Excise Tax Exemption Certificate upon request.
- B. Public Inspection of Bids: The County strictly adheres to the Texas Public Information Act (Texas Government Code Chapter 552.001, et seq.) and all other governing statutes, regulations, and laws regarding the disclosure of RFB information. Bids are not available for public inspection until after the contract award. If the Bidder has notified the County, in writing, that the Bid contains trade secrets or confidential information, the County will generally take reasonable steps to prevent disclosure of such information, in accordance with the Public Information Act. This is a statement of general policy only, and in no event shall the County be liable for disclosure of such information by the County in response to a request, regardless of the County’s failure to take any such reasonable steps, even if the County is negligent in failing to do so.
- C. Legal Relations and Responsibilities: Bidder shall maintain adequate records to justify all charges, expenses and costs incurred in performing the Services for a period of at least Five (5) years following the termination date of the contract. The County shall have full and complete access to all records, documents and information collected and/or maintained by Bidder in the course of the administration and performance of the Contract. This information shall be made accessible at Bidder’s local place of business in the County’s

jurisdiction, for purposes of inspection, reproduction and audit without restriction.

- D. Application: These standard terms and conditions shall apply to all County of Bastrop (hereafter “County” or “Owner”) solicitations and procurements, unless specifically accepted in the solicitation specifications.
- E. Requirements: By submitting a Bid, the bidder agrees to provide the County of Bastrop with the specified goods or services described in the solicitation in accordance with these standard terms and conditions, at the agreed upon Bid price and in compliance with the stated specifications and any subsequent addendums issued prior to the date of the Bid opening.
- F. Legal Compliance: Bidder must comply with all Federal, State and Local laws, statutes, ordinances, regulations and standards in effect at the time of delivery of goods and services, and must maintain any and all required licenses and certificates required under the same laws, statutes, ordinances, regulations and standards for services and/or goods provided in response to this solicitation. Bidder certifies that he/she holds all licenses required by the State of Texas for a provider of the goods and/or services described by the Scope of Services herein.
- G. Right to Refuse Bid: The County reserves the right to refuse any and/or all parts of any and or/all Bids and to waive formalities in the best interest of the County. Bastrop County does not discriminate on the basis of race, color, national origin, sex, religion, and age or disability status in employment, procurement or provisions of service.
- H. Estimated Quantities: This solicitation calls for unit pricing based on a range of material usage. Bastrop County does not guarantee quantities of these items. The actual amount ordered over the contract period may be more or less than the estimate. Quantities represent the County’s best estimate, based on past history and anticipated purchases.
- I. Independent Contractor: Bidder agrees that Bidder and Bidder’s employees and agents have no employer-employee relationship with County. Bidder agrees that if Bidder is selected and awarded a contract, County shall not be responsible for the Federal Insurance Contribution Act (FICA) payments, Federal or State unemployment taxes, income tax withholding, Workers Compensation Insurance payments, or any other insurance payments, nor will County furnish any medical or retirement benefits or any paid vacation or sick leave.
- J. Assignments: The rights and duties awarded the successful Bidder shall not be assigned to another without the written consent of the Bastrop County Purchasing Agent. Such consent shall not relieve the assigner of liability in the event of default by the assignee.
- K. Liens: Bidder shall indemnify and save harmless the County against any and all liens and encumbrances for all labor, goods, and services which may be provided to the County by Bidder or Bidder’s vendor(s), and if the County requests, a proper release of all liens or satisfactory evidence of freedom from liens shall be delivered to the County.
- L. Gratuities/Bribes: Bidder certifies that no bribes in the form of entertainment, gifts, or otherwise, were offered or given by the successful Bidder, or its agent or representative, to any County officer, employee or elected representative, with respect to this RFB or any contract with the County, and that if any such bribe is found to have been made this shall be grounds for voiding of the contract
- M. Financial Participation: Bidder certifies that it has not received compensation from the County to participate in preparing the specifications or RFB on which the Bid is based and acknowledges that this contract may be terminated and/or payment withheld if this certification is inaccurate.

- N. Responsiveness of Bids: The County desires to receive competitive Bids but will declare any Bids “non-responsive” if they fail to meet the significant requirements outlined in this solicitation document.
- O. Discrepancies and Errors: The unit prices of a bid that has been opened may not be changed for the purpose of correcting an error in the Bid price.
- P. Identical Bids: In the event two or more identical Bids are received, and are lowest, responsible and responsive, award will be made as prescribed in the Texas Local Government Code, Chapter 2.62.027(b).
- Q. Withdrawal of Bids: Bidders may withdraw any submitted bids prior to the bid submission deadline. Bidders may not withdraw once the bids have been publicly opened, without the approval of the County’s Purchasing Agent. Bidders will be allowed to withdraw bids that contain substantial mathematical errors in extension. However, once a bid has been withdrawn, it can no longer be considered.
- R. Disqualification of Bidder: The County may disqualify bidders, and their bids not be considered, for any of the following reasons: Collusion among bidders; bidder’s default on an existing or previous contract with the County, including failure to deliver goods and/or services of the quality and price bid; bidder’s lack of financial stability; any factor concerning the bidder’s inability to provide the quantity, quality, and timeliness of services or goods specified in the solicitation; bidder involved in a current or pending lawsuit with the County; bidder’s attempt to influence the outcome of the solicitation through unauthorized contact with County officials outside of those listed in the solicitation documents; and bidder’s attempt to offer gifts, gratuities, or bribes to any County employee or elected official in connection with a solicitation.
- S. Waiver of Formalities: County reserves the right to reschedule, extend, or cancel this RFB at any time. County reserves the right to reject any or all responses, and to waive formalities or irregularities in connection with this RFB and may consider submissions not made in compliance with this request for bids if it elects to do so, to the extent permitted by law, although the County will have no obligation for such consideration. The County reserves the right to waive any minor irregularities that do not materially affect the scope or pricing of submitted Bids.
- T. Outstanding Liabilities: Bidders shall not have outstanding, unpaid liabilities owed to the County. Liabilities may include, but are not limited to, property taxes, hotel occupancy taxes, and license or permit fees. Bids will be considered non-responsive and not given further consideration if submitted by a bidder with such outstanding liabilities.
- U. Offset: The County may, at its option, offset any amounts due and payable under contract award under this solicitation against any debt lawfully due the County from a vendor, whether or not the amount due arises pursuant to the terms of the contract and whether or not the debt has been reduced to judgment by a court.
- V. Solicitation Results: The County normally posts solicitation results on-line after bids are received and approved in Commissioner’s Court. The County’s website is www.co.bastrop.tx.us. Results are on the Purchasing Solicitation page, in the same place as the original solicitation documents. Posted results are for informational purposes only, not a notice of award.
- W. Control of The Work: Bidder shall furnish all materials and perform work in reasonably close conformity with the scope of work referenced in this request for Bid. Bidder must obtain written approval from Bastrop County before deviating from the scope of work provided in this request for bids. Failure to promptly notify Bastrop County of any errors or concerns with the scope of work will constitute a waiver of all claims for misunderstandings or ambiguities that result from the errors, omissions, or discrepancies discovered.

- X. Cost of Bid: The cost of submitting Bids shall be borne by the Bidder, and the County will not be liable for any costs incurred by a Bidder responding to this solicitation.

4. RFB Withdrawals and/or Amendments

- A. RFB Withdrawal: The County reserves the right to withdraw this RFB for any reason.
- B. RFB Amendments: The County reserves the right to amend any aspect of this RFB by formal written Addendum prior to the bid submittal deadline and will endeavor to notify all potential bidders that have registered with the County, but failure to notify shall impose no obligation or liability on the County. All modifications and addendums must be in written form prepared by the County department issuing the solicitation. Bidder is responsible for incorporating any and all modifications and addendums into their bids.

5. Bid Submittal Requirements

- A. Submittal Packet – Required Content: Bidder shall submit one (1) signed original Bid. This submittal packet shall be submitted in a sealed envelope with all items listed on Appendix B of this bid document (Page 21).
- B. Submittal Deadline: The deadline for submittal of Bids is 2:00PM (CST) June 18, 2026. It is the Bidder's responsibility to have the Bid correctly marked and hard copies delivered to the Bastrop County Purchasing Office. No extensions will be granted, and no late Bids will be accepted.
- C. Bids Received Late: Bidders are encouraged to submit their Bids as soon as possible. The time and date of receipt as recorded in the Bastrop County Purchasing Office shall be the official time of receipt. The County is not responsible for late delivery of mail or other carrier. Late Bids will not be considered under any circumstances.
- D. Alterations or Withdrawals of Bid: Any submitted Bid may be withdrawn or a revised Bid substituted if a written notice is submitted to the Bastrop County Purchasing Office prior to the submittal deadline. Any interlineations, alteration, erasure or other amendment made before the submittal deadline, must be signed or initialed by the Bidder or the Bidder's authorized agent, guaranteeing authenticity. Bids cannot be altered, amended or withdrawn by the Bidder after the submittal deadline.
- E. Bid Format: All Bids must be prepared in single-space type, on standard 8-1/2" x 11" vertically oriented pages, using one side of the paper only. Pages shall be numbered at the bottom. Entries shall be typed, or legibly written in ink. All Bids shall be mailed or hand delivered to Bastrop County. Any other format (via telephone, fax, email, etc.) shall be rejected by the County.
- F. Validity Period: Once the submittal deadline has passed, any Bid shall constitute an irrevocable Bid to provide the commodities and/or services set forth in the Scope of Services at the price(s) shown in the Bid on the terms set forth in the Bid, such Bid to be irrevocable until the earlier of the expiration of ninety (90) days from the submittal deadline, or until a contract has been awarded by the County.

6. Bid Evaluation and Contract Award

- A. Bid Evaluation and Contract Award Process: An award of a contract to provide the goods or services specified herein will be made using competitive sealed bids, in accordance with Chapter 262 of the Texas Local Government Code, Chapter 2269 of the Texas Government Code and with the County's purchasing policy. All bids should be based on unit pricing (Cost per ton of material or per Linear Foot to complete all task listed within Appendix A to include all necessary bonds and insurance). Bastrop County will score all eligible respondents based on their bid price. The contract will be given to the lowest/best value/most responsive bidder that complies with all requests for bid items and requirements set forth by Bastrop County in this RFB, to include bonds, insurance requirements and Bastrop County may consider: 1) price: 2) the offeror's

experience and reputation: 3) the quality of the offeror's goods and/or services: 4) the impact on the ability of the Governmental entity to comply with rules relating to historically underutilized businesses: 5) the offeror's safety record: 6) the offeror's proposed personnel: 7) whether the offeror's financial capability is appropriate to the size and scope of the project. The selected bidder must NOT be debarred from any federal and/or state agency and Bastrop County will conduct a review of the bidder's status on SAM.Gov. The Bastrop County Commissioners' Court will make the final selection and award. **The County has the right to reject any and/or all Responses.**

- B. Completeness: If the Bid is incomplete or otherwise fails to conform to the requirements of the RFB, County alone will determine whether the variance is so significant as to render the bid non-responsive, or whether the variance may be cured by the bidder or waived by the County, such that the bid may be considered for award.
- C. Ambiguity: Any ambiguity in the bid as a result of omission, error, lack of clarity or non-compliance by the bidder with specifications, instructions and all conditions shall be construed in the favor of the County. In the event of a conflict between these standard RFB requirements and details provided in Appendix A – Scope of Services or Appendix B – Bid, the Appendices shall prevail.
- D. Controlling Document: In the case of a discrepancy between this solicitation and the formal contract, the formal contract will prevail and control.
- E. Firm Prices: Unless otherwise stated in the specifications, Bidder's prices remain firm for 90 days from date of Bid opening and, upon award, remain in effect for the contract period specified in the solicitation. If formal award has not occurred within 90 days of bid opening, the Contractor and the County may mutually agree to extend the firm price period.
- F. Additional Information: County may request any other information necessary to determine bidder's ability to meet the minimum standards required by this RFB.
- G. Debarment: The selected Bidder must **NOT** be debarred from any federal and/or state agency and Bastrop County will conduct a review of the Bidder's status on SAM.Gov. The Bastrop County Commissioners' Court will make the final selection and award. The County has the right to reject any and/or all Responses.

****THE REMAINDER OF THIS PAGE LEFT BLANK INTENTIONALLY****

Appendix A – Scope of Services

1. **Project Title:** TxDOT Recommend Erosion Control and Repairs Project - Precinct 3

2. **Scope of Services Contact:**

Questions about the technical nature of the Scope of Services, etc. may be directed to Bastrop County Purchasing Agent, Leon Scaife through e-mail at leon.scaife@co.bastrop.tx.us

3. **Bid Evaluation Factors:**

| Bid Price | Factor |
|----------------|---|
| Lump Sum Price | Cost to complete all task listed within “Scope of Services” based on cost of labor, material, equipment, mobilization, insurance and bonds. |

4. **Key Events Schedule:**

| | |
|---|---------------------|
| Bid Release Date | May 27, 2026 |
| Deadline for Submittal of Written Questions | 5 PM, June 11, 2026 |
| Sealed Bids Due to and Opened by County | 2 PM, June 18, 2026 |
| Anticipated Award Date | July 2026 |

5. **Scope of Services:**

Project Overview:

Bastrop County is in need of a contractor to provide erosion control measures and to replace a damaged/broken guardrail extruder terminal.

500 block of Lower Red Rock Road (Latitude 30.05742079 – Longitude -97.37141479) (See Site Map 1A) - The contractor shall refer to TXDOT Standard Sheet SCT (14W) 31-18 for “Retrofit Standard SKT 31” Wood Post System To Mash MSKT”. This site has severe impact damage to SE corner guardrail extruder terminal with broken and detached end posts and the flex beam is extruding towards the traffic. The contractor shall replace the damaged end terminal.

300 Block of High Grove Road (Latitude 30.02287962 – Longitude -97.46835953) (See Site Map 2A) – Erosion exposure has occurred at both (Northeast and Southwest) abutment footings and wingwall footings. Moderate contraction scour and runoff erosion have exposed both abutment footings and the wingwall footings. The bottom of all footings are exposed, and the north and east wingwall footings are undermined up to 2.5' at the abutment footing connection. The contractor shall backfill undermined portions of the NE abutment wall and place 18-inch stone riprap along abutment wall footings as erosion countermeasure.

Contractor shall remove and replace approximately 100 feet of 5-strand barbed wire fencing at the project site.

500 Block of Pettytown Road (Latitude 29.93374960 – Longitude -97.44409530) (See Site Map 2B) – Erosion exposure has occurred at both (Northeast and Southwest) abutment footings and wingwall footings. Moderate contraction scour has exposed the drilled shafts at the southwest abutment as much as 4.3' and the abutment cap is completely undermined. The southwest embankment is also undermined

up to 1.3' back from the back of the cap and 2' upward from the bottom of the cap. Erosion at the northeast abutment exposes the bottom section of the cap up to 2.5' below the original ground line. Contractor shall repair undermining of SW abutment and SW approach embankment with stabilized backfill material. Contractor shall install 18-inch stone riprap to protect the abutments.

Bastrop County has estimated the following quantities of material and services that will be needed to complete all tasks for this project; however, Contractors should field verify the project scope before submitting a bid:

| ITEM | DESCRIPTION | QUANTITY | UNIT |
|------|---|----------|------|
| 432 | RIPRAP (STONE PROTECTION) (18 IN) | 208 | CY |
| 500 | MOBILIZATION | 1 | LS |
| 502 | BARRICADES, SIGNS & TRAFFIC HANDLING | 1 | MO |
| 544 | GUARDRAIL END TREATMENT (INSTALL) | 1 | EA |
| 544 | GUARDRAIL END TREATMENT (REMOVE) | 1 | EA |
| | BARBED WIRE FENCE (5-WIRE) (REMOVE AND INSTALL) | 100 | LF |

** All specifications should follow TXDOT Standards Specifications for Construction and Maintenance of Highways, Streets and Bridges.*

***Traffic control must comply with the TMUTCD (Texas Manual on Uniform Traffic Control Devices) and TxDOT's Barricade and Construction (BC) standard sheets.*

The selected contractor **SHALL** mobilize and start work within Fifteen (15) days of receipt of a Notice-To-Proceed issued by Bastrop County. Payment and Performance bonds shall be required and issued for this contract should the total bid price for this project reach the State of Texas threshold for public works projects. The contractor agrees that, before any work begins, a Payment Bond will be executed and delivered to Bastrop County for the amount of one hundred percent (100%) of the estimated project total, should the contracted total meet and/or exceed twenty-five thousand dollars (\$25,000). A Performance bond in an amount of one hundred percent (100%) of the estimated project price should also be executed and delivered to Bastrop County should the contracted amount meet and/or exceed one hundred thousand dollars (\$100,000). The Performance and/or Payment Bond must be maintained throughout the contracted project execution period. At the completion of all work on the requested project, the Payment and/or Performance Bond shall be released. Cost of all bonds must be included in the bid price.

****THE REMAINDER OF THIS PAGE LEFT BLANK INTENTIONALLY****

Lower Red Rock Road - Guardfence Extruder Terminal

MAP 1A

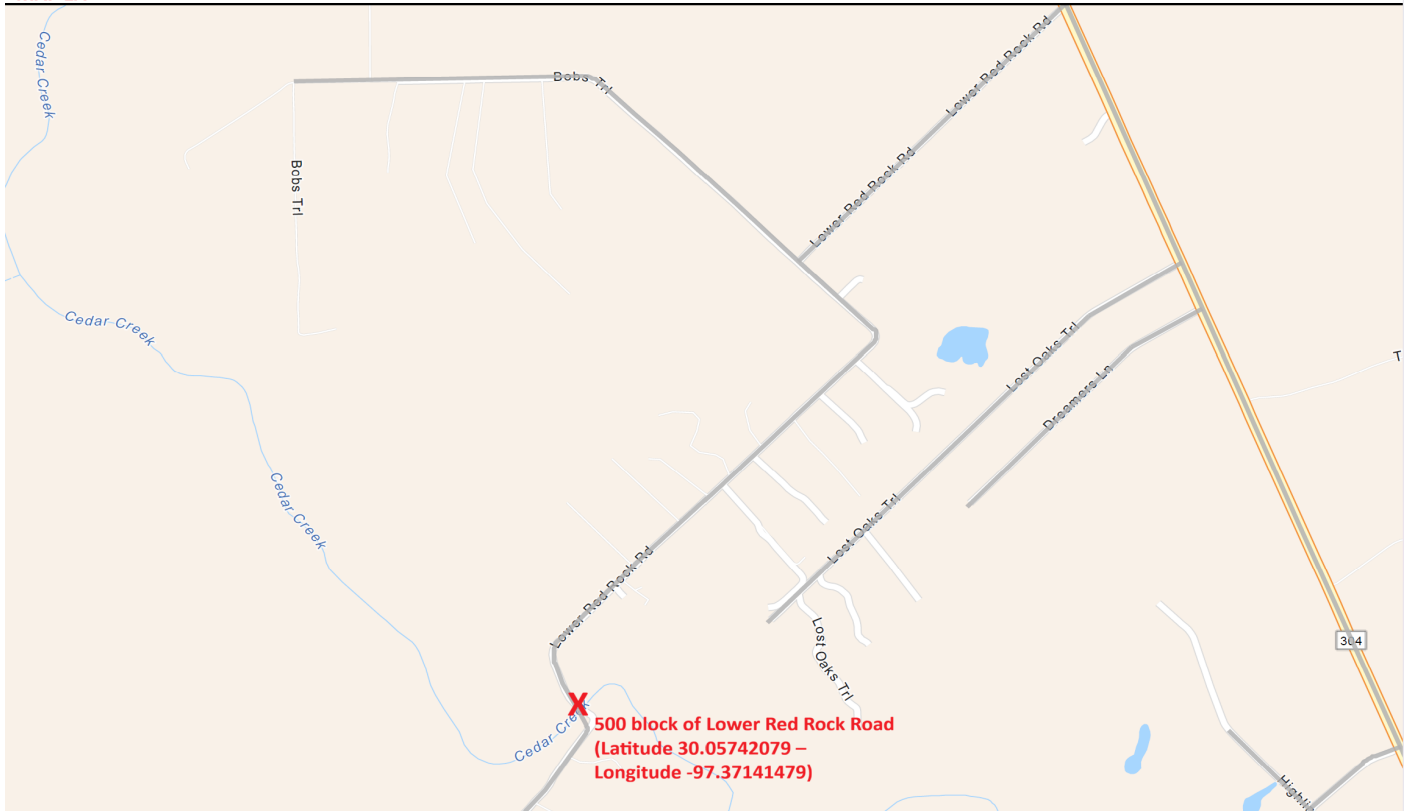

IMPACT DAMAGE TO EAST CORNER GUARDFENCE EXTRUDER TERMINAL WITH BROKEN AND DETACHED END POSTS LOOKING NORTHEAST



DISCLAIMER: THE USE OF THIS STANDARD IS GOVERNED BY THE TEXAS ENGINEERING PRACTICE ACT. NO WARRANTY OF ANY KIND IS MADE BY TxDOT FOR ANY PURPOSE WHATSOEVER. THE USER ASSUMES RESPONSIBILITY FOR THE CONSTRUCTION OF THIS STANDARD TO OTHER STANDARDS OR TO CORRECT RESULTS OR DAMAGES RESULTING FROM ITS USE.

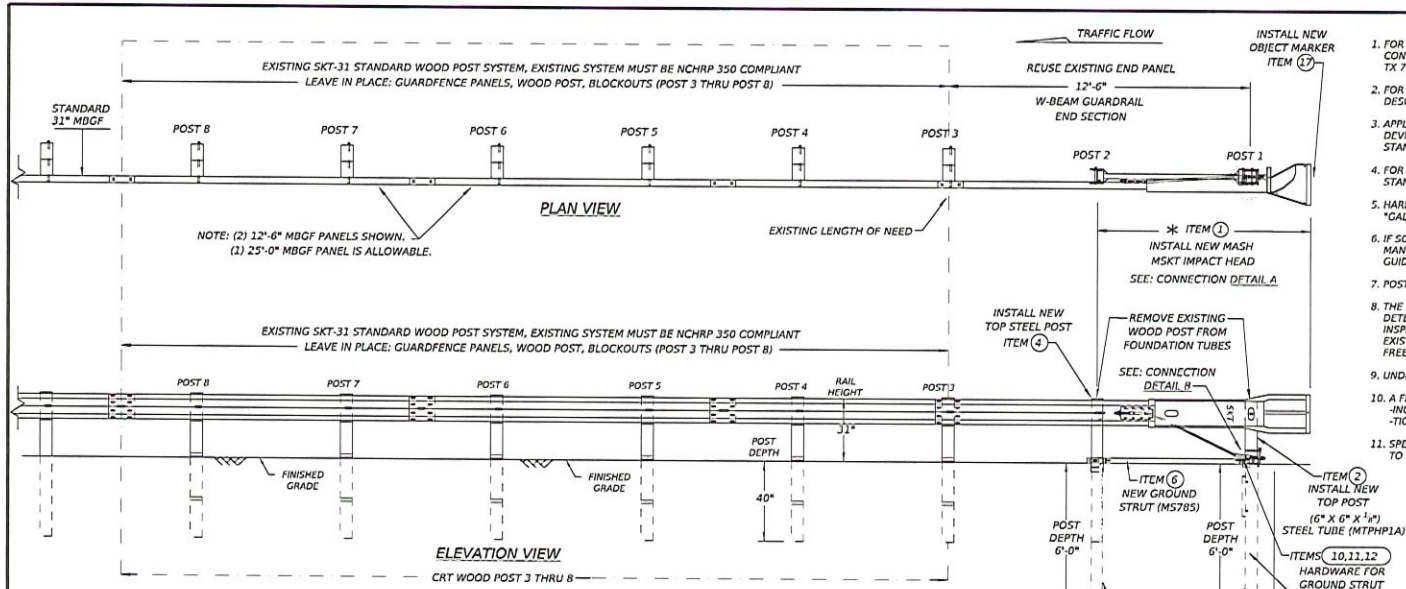

GENERAL NOTES

- FOR SPECIFIC INFORMATION REGARDING INSTALLATION AND TECHNICAL GUIDANCE OF THE SYSTEM, CONTACT: ROAD SYSTEMS, INC. (432)263-2425, 3616 OLD HOWARD COUNTY AIRPORT, BIG SPRING, TX 79720
- FOR INSTALLATION, REPAIR AND MAINTENANCE REFER TO: MSKT END TERMINAL, PRODUCT DESCRIPTION ASSEMBLY MANUAL (PUBLICATION-062717).
- APPLY HIGH INTENSITY REFLECTIVE SHEETING, "OBJECT MARKER" ON THE FRONT FACE OF THE DEVICE PER MANUFACTURER'S RECOMMENDATIONS. OBJECT MARKER SHALL CONFORM TO THE STANDARDS REQUIRED IN TEXAS MUTCD.
- FOR POST (LEAVE-OUT) INSTALLATION AND GUIDANCE SEE TxDOT'S LATEST ROADWAY MOW STRIP STANDARD.
- HARDWARE (BOLTS, NUTS, & WASHERS) SHALL BE GALVANIZED IN ACCORDANCE WITH ITEM 445, "GALVANIZING". FITTINGS SHALL BE SUBSIDIARY TO THE BID ITEM.
- IF SOLID ROCK IS ENCOUNTERED IN THE AREA OF (POST 1) AND / OR (POST 3) CONTACT THE MANUFACTURER, AND REFER TO THE LATEST ROADWAY MBGF STANDARD FOR INSTALLATION GUIDANCE.
- POSTS SHALL NOT BE SET IN CONCRETE.
- THE EXISTING SKT 31* STANDARD WOOD POST SYSTEM MUST BE THOROUGHLY INSPECTED, AND DETERMINED TO BE INTACT, AND FREE OF ANY DAMAGE OR DEFECTS BEFORE RETROFITTING. THIS INSPECTION INCLUDES COMPLETING THE MSKT RETROFIT INSPECTION CHECKLIST FOR THE EXISTING SKT 31* WOOD POST NCHRP 350 SYSTEM. ALL EXISTING, AND REUSABLE PARTS MUST BE FREE OF ANY DAMAGE FOR A MASH COMPLIANT RETROFIT.
- UNDER NO CIRCUMSTANCES SHALL THE GUARDRAIL WITHIN THE MSKT SYSTEM BE CURVED.
- A FLARE RATE OF UP TO 25:1 MAY BE USED TO PREVENT THE TERMINAL HEAD FROM ENCRUCHING ON THE SHOULDER. THE FLARE MAY BE DECREASED OR ELIMINATED FOR SPECIFIC INSTALLATIONS, IF DIRECTED BY THE ENGINEER.
- SPECIAL DRIVING CAP TO BE USED WHEN DRIVING (LOWER POSTS 1 & 2) TO PREVENT DAMAGE TO THE WELDED PLATES.

| ITEMS | QTY | MAIN SYSTEM COMPONENTS | PART NUMBERS |
|-------|-----|------------------------------------|--------------|
| 1 | 1 | MSKT IMPACT HEAD | MS3000 |
| 2 | 1 | POST 1 - TOP (6" X 6" X 1/4" TUBE) | MTPHP1A |
| 3 | 1 | POST 1 - BOTTOM (6" W6X15) | MTPHP1B |
| 4 | 1 | POST 2 - ASSEMBLY TOP | UHP2A |
| 5 | 1 | POST 2 - ASSEMBLY BOTTOM (6" W6X9) | HP2B |
| 6 | 1 | GROUND STRUT | MS785 |
| 7 | 2 | 3/8" X 1" HEX BOLT (GRD 5) | B516014A |
| 8 | 4 | 1/4" WASHERS | W0516 |
| 9 | 2 | 1/4" HEX NUT | N0516 |
| 10 | 2 | 3/4" X 9" HEX BOLT (GRD A449) | B580904A |
| 11 | 3 | 1/2" WASHERS | W050 |
| 12 | 3 | 1/2" H.G.R. NUT | N050 |
| 13 | 1 | 3/4" X 1 1/4" SPLICE BOLT | B580122 |
| 14 | 1 | 3/4" X 8 1/2" HEX BOLT (GRD 5) | B340854A |
| 15 | 1 | 3/4" HEX NUT | N030 |
| 16 | 1 | CABLE TIE-STEEL | CT-1005T |
| 17 | 1 | OBJECT MARKER 18" X 18" | F3151 |

COMPONENTS REQUIRED TO RETROFIT: EXISTING 31* WOOD POST (NCHRP 350 SKT) GUARDRAIL TERMINAL WITH THE NEW 31* (MASH COMPLIANT MSKT IMPACT HEAD).
 * IF THE EXISTING NCHRP 350 (31* WOOD POST SKT) ALREADY HAS THE MSKT IMPACT HEAD THERE IS NO NEED TO REPLACE THE IMPACT HEAD OR OBJECT MARKER AS LONG AS IT IS NOT DAMAGED.

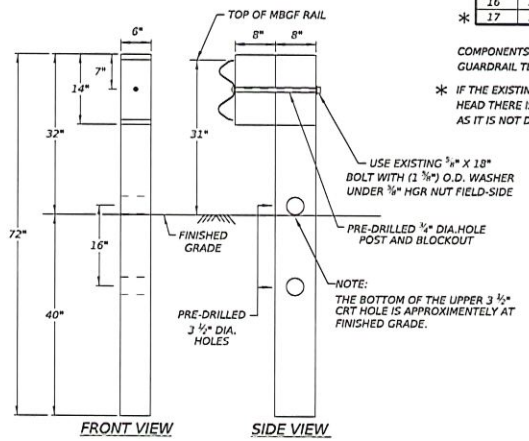
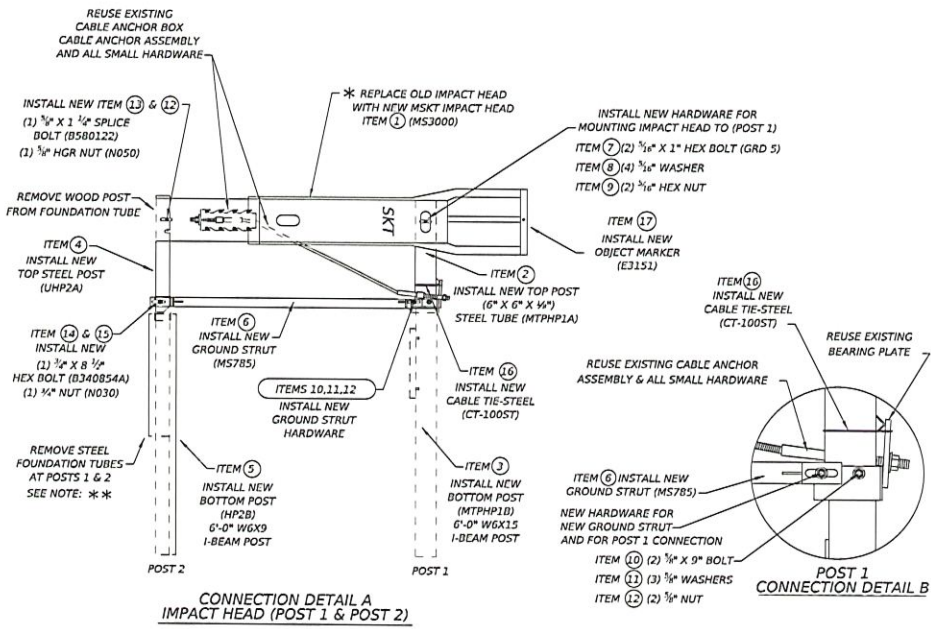

EXISTING WOOD POSTS 3-8 CONTROLLED RELEASE TERMINAL (CRT)
 NOTE: THIS STANDARD IS A BASIC REPRESENTATION OF THE EXISTING SKT END TERMINAL RETROFITTED TO THE MSKT MASH COMPLIANT TERMINAL. IT IS NOT INTENDED TO REPLACE THE PRODUCT DESCRIPTION ASSEMBLY MANUAL.

Design Division Standard

RETROFIT STANDARD
 SKT 31* WOOD POST SYSTEM
 TO MASH SKT
 SGT (14W) 31-18

| | | | | | | | | | |
|-----------|----------------|-------|-------|------|------|-----|---------|-----|----|
| FILE# | RP114W3118.dgn | DN# | TxDOT | CR# | KM | DN# | VP | CR# | CL |
| © | TxDOT | APRIL | 2018 | CONT | SECT | JOB | HIGHWAY | | |
| REVISIONS | | | | | | | | | |
| | | | | | | | | | |
| | | | | | | | | | |

DATE: FILE:

High Grove Road - Bridge Abutment

MAP 2A

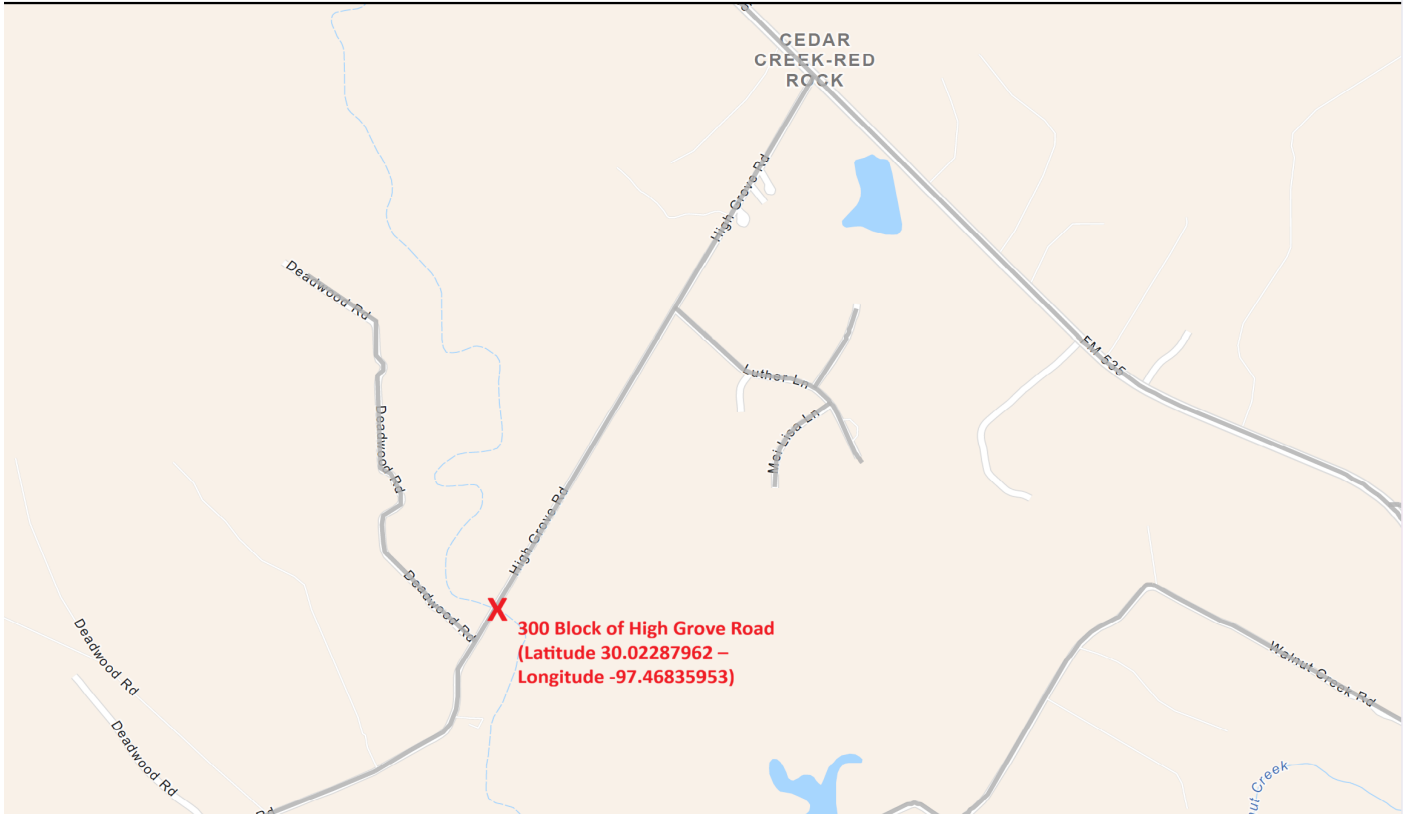

NE ABUTMENT FOOTING EXPOSED AND UNDERMINED AT WINGWALL CONNECTIONS



UNDERMINED NORTH CORNER WINGWALL LOOKING NORTHEAST



UNDERMINED EAST CORNER WINGWALL LOOKING NORTHEAST



SW ABUTMENT FOOTING EXPOSED LOOKING SOUTHWEST



Pettytown Road - Bridge Abutment

MAP 2B

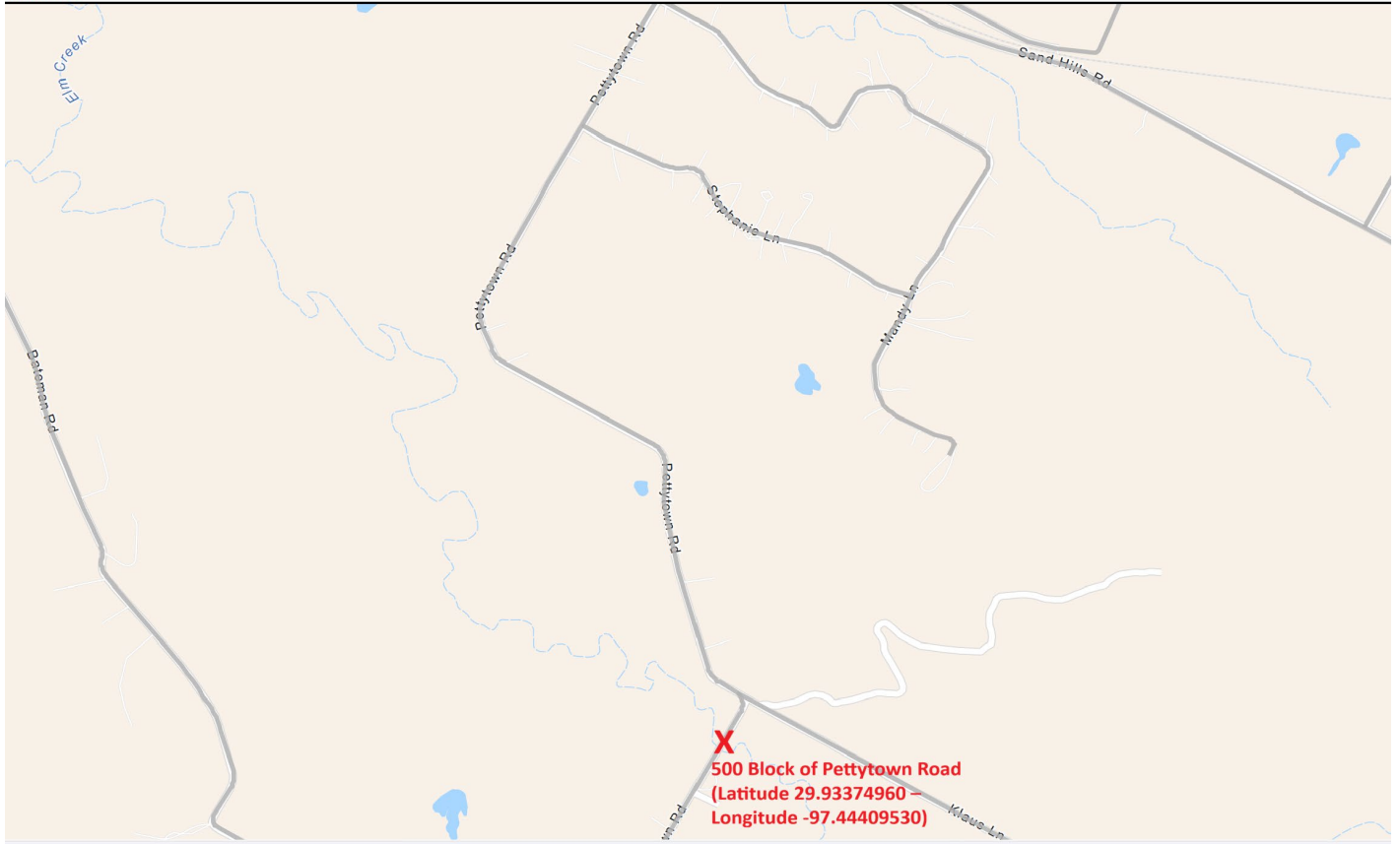

SOUTHWEST ABUTMENT CAP UNDERMINED UP TO 3.8-FT LOOKING SOUTH



SOUTHWEST ABUTMENT DRILLED SHAFTS ARE EXPOSED LOOKING SOUTHWEST



NORTHEAST ABUTMENT FOUNDATION IS EXPOSED LOOKING EAST



DISCLAIMER:
The use of this standard is governed by the Texas Engineering Practice Act. No warranty of any kind is made by TxDOT for any purpose whatsoever. TxDOT assumes no responsibility for the conception of this standard or for incorrect results or damages resulting from its use.

DATE:
FILE:

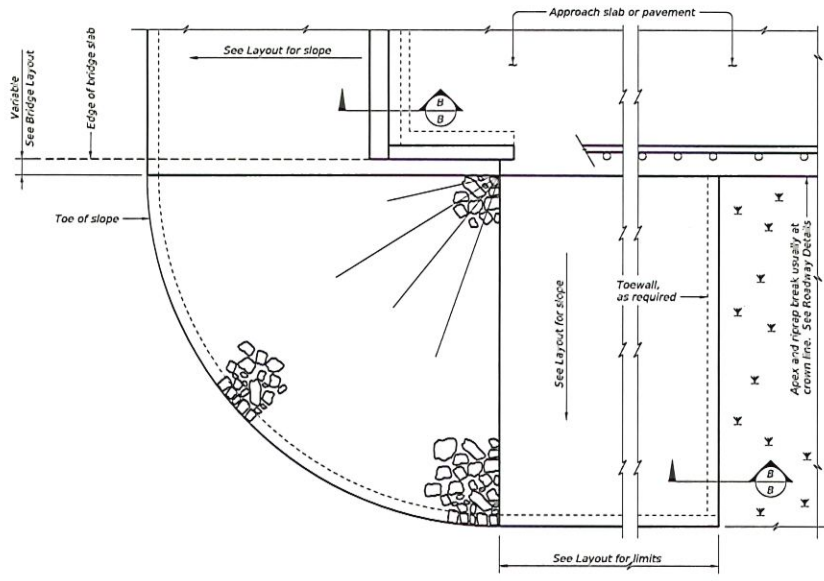

PLAN

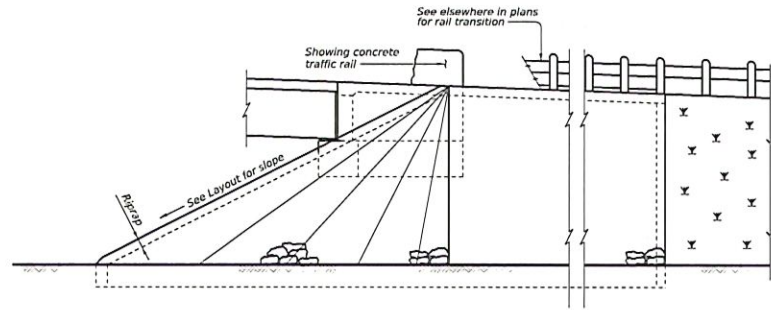

ELEVATION

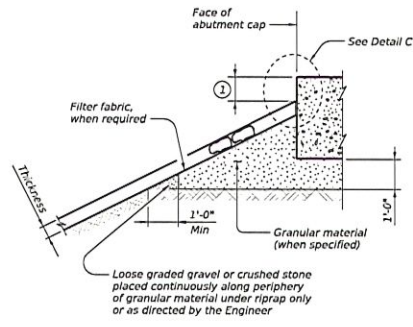

SECTION A-A AT CAP

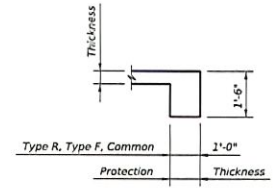

SECTION B-B

Provide toewall when shoulder drain is located adjacent to limits of stone riprap. Omit toewall when thickness of protection riprap is greater than 18".

1 Top of cap to top of riprap dimension varies as directed by the Engineer. Provide 9" Min for beam/slab type bridges and 1'-0" for slab span, box beam, or slab beam bridges.

8" X 18 Gauge galvanized flashing full length of cap

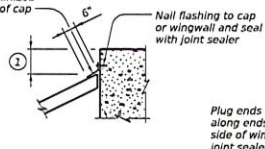

CAP OPTION A

8" X 18 Gauge galvanized flashing full length of cap

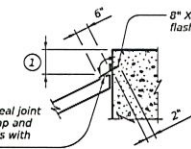

CAP OPTION B

DETAIL C

GENERAL NOTES:
Refer to Item 432, "Riprap" for stone size and gradation, and construction details. See Layout for limits and thickness of riprap specified.
See elsewhere in plans for locations and details of shoulder drains.

SHEET 1 OF 2

| | | | |
|---|--------------|--------------------------|----------------------|
| | | Bridge Division Standard | |
| STONE RIPRAP | | | |
| SRR | | | |
| P&P MS-SRR-24.dgn TxDOT October 2024 | DATE CUNT | SEC R/W | SHEET NO. HIGHWAY |
| REVISIONS | | COUNTY | SHEET NO. |

DISCLAIMER:
 The use of this standard is governed by the "Texas Engineering Practice Act". No warranty of any kind is made by TxDOT for any purpose whatsoever. TxDOT assumes no responsibility for the conversion of this standard to other formats or for incorrect reproduction or misinterpretation resulting from its use.

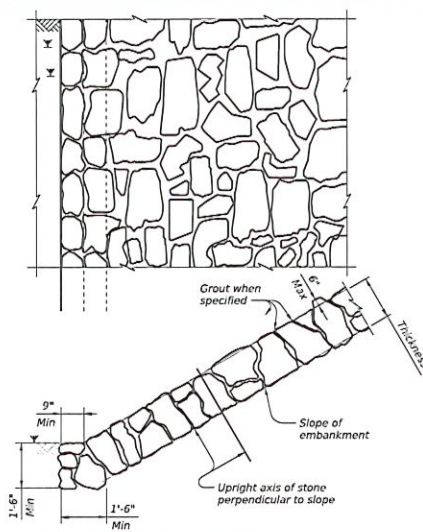

FIGURE 1 ~ TYPE R STONE RIPRAP
 Dry or grouted

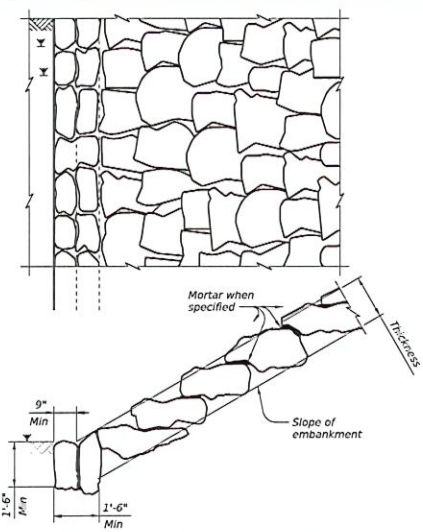

FIGURE 2 ~ TYPE F STONE RIPRAP
 Dry or mortared

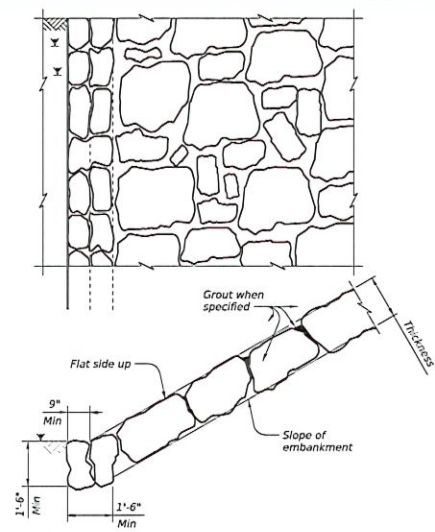
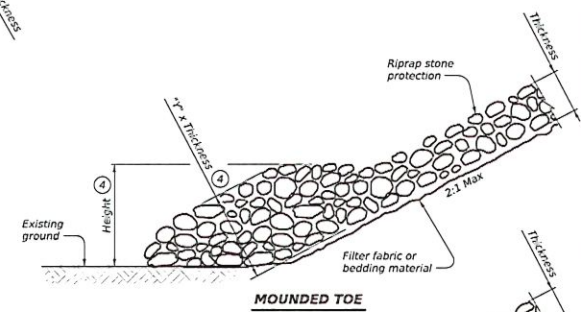
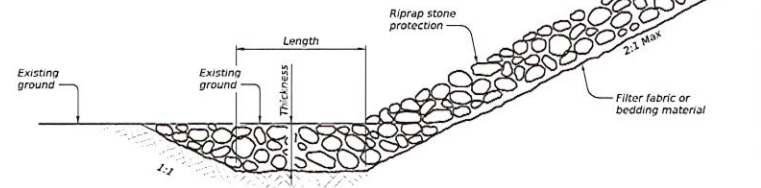

FIGURE 3 ~ TYPE F STONE RIPRAP
 Grouted

- ② Provide bedding material instead of filter fabric if shown elsewhere in plans. See Layout for thickness of bedding material.
- ③ Minimum toe depth is 2 times the riprap thickness (typical) or as shown elsewhere in the plans.
- ④ "Y" and Height need to be defined. See layout or detail sheet for values if this option is used.
- ⑤ List Stone Protection as size (XX inch) and thickness (YY inch) on the layout.
 Example: Riprap (Stone Protection) XX inch, Thickness = YY inch.



MOUNDED TOE



EXTENDED ROCK FILLED TRENCH

PROTECTION STONE RIPRAP TOE OPTIONS ⑤

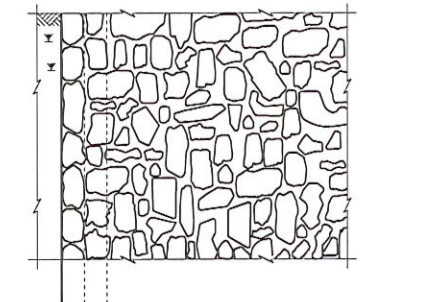

FIGURE 4 ~ COMMON STONE RIPRAP
 Dry or grouted

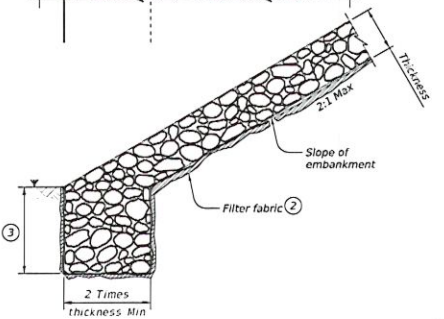

FIGURE 5 ~ PROTECTION STONE RIPRAP ⑤

DATE:
 FILE:

| | | | |
|---|------------------------|--------------------------|------------------------------|
| | | Bridge Division Standard | |
| <h2>STONE RIPRAP</h2> | | | |
| <h3>SRR</h3> | | | |
| P&E MS-588-24.dgn © TxDOT October 2024 REVISIONS: | DATE: TxDOT COUNTY: | DRAWN BY: TxDOT JUN: | CHECKED BY: TxDOT COUNTY: |
| | | SHEET NO. | |

BID SHEET

RFB 26BCP05B - TxDOT Recommend Erosion Control and Repairs Project - Precinct 3

| | | |
|--|----|----------------|
| COST TO COMPLETE ALL TASKS REQUIRED AT LOWER RED ROCK ROAD | \$ | Lump Sum |
| COST TO COMPLETE ALL TASKS REQUIRED AT HIGH GROVE ROAD | \$ | Lump Sum |
| COST TO COMPLETE ALL TASKS REQUIRED AT PETTYTOWN ROAD | \$ | Lump Sum |
| COST OF BONDS (PAYMENT AND PERFORMANCE) | \$ | Lump Sum |
| ESTIMATED NUMBER OF DAYS TO COMPLETE PROJECT | # | Days |
| TOTAL PROJECT COST FOR ALL THREE SITES (LABOR, MATERIALS, BONDS) | \$ | Lump Sum |
| COST OF ADDITIONAL 18-INCH STONE RIPRAP <i>(This is the cost that Bastrop County will pay for any material overages should the needed quantity exceed 208 cubic yards)</i> | \$ | Per Cubic Yard |
| AVAILABLE START DATE: _____ (Day) _____ (Month), 2026 | | |

Authorized Signatory:

Date:

Appendix B – Bid Verification

Submittal Checklist: (To determine validity of Bid - all bids received without the following items will be considered non-responsive and will be rejected. Forms from previous solicitations for goods or services will not be used in place of the required forms for this RFB)

- _____ Appendix A (Pages 9 through 20) must be completed, signed and included in the Bid submittal.
- _____ Appendix B (Pages 21 through 28) must be completed, signed and included in the Bid submittal.
- _____ Appendix C – Conflict of Interest Form (CIQ Form) (Page 29) must be completed, signed and included in the Bid submittal.
- _____ Appendix E – HB 89 Verification Form (Page 34) must be completed, signed and included in the Bid submittal.
- _____ Certificate of Insurance showing Proof of Contractor’s Ability to Meet the Insurance Requirements (Page 26).
- _____ Signed Addendum(s) (If any are issued by Owner).

| All Bids submitted to Bastrop County shall include this page with the submitted Bid. | | |
|---|--|--|
| RFB Number: | RFB 26BCP05B | |
| Project Title: | TxDOT Recommend Erosion Control and Repairs | |
| Submittal Deadline: | 2:00 P.M. (CST), June 18, 2026 | |
| Submit hard-copies to: | MAIL: Bastrop County Purchasing Department: Attn: Leon Scaife 1501 Business Park Drive Bastrop Texas, 78602 | HAND DELIVER: Bastrop County Purchasing Department: Attn: Leon Scaife 1501 Business Park Drive Bastrop Texas, 78602 |
| | Bidder Information: | |
| Bidder’s Legal Name: | | |
| Address: | | |
| City, State & Zip | | |
| Federal Employers Identification Number # | | |
| Bidder’s Point of Contact: | | |
| Phone Number: | | Fax Number: |
| E-Mail Address: | | |
| Bidder Authorization | | |
| <p>I, the undersigned, have the authority to execute this Bid in its entirety as submitted and enter into a contract on behalf of the Bidder.</p> <p>Printed Name and Position of Authorized Representative: _____</p> <p>Signature of Authorized Representative: _____</p> <p>Signed this _____ (day) of _____ (month), _____ (year)</p> | | |

Appendix B – Bid (continued)

I. CONTRACT AWARD INFORMATION:

A. Term of Contract

Any contract resulting from this RFB shall be effective from the date that the contractor is issued a Notice-To-Proceed and shall remain in effect for the number of Days provided by the Contractor on the attached bid sheet. This contract may be extended if it is in the best interest of Bastrop County.

B. Federal, State and/or Local Identification Information

- 1) Centralized Master Bidders List registration number: _____
- 2) Prime contractor HUB / MWBE registration number: _____
- 3) Employer Identification Number (EIN)/Federal Tax Identification Number: _____
- 4) An individual Bidder acting as a sole proprietor must also enter the Bidder’s Social Security Number:
_____ - _____ - _____.

II. CONTRACT TERMS AND CONDITIONS. EXCEPT WHERE BIDDER MAKES SPECIFIC EXCEPTION IN THE SUBMITTED BID, ANY CONTRACT RESULTING FROM THIS RFB WILL CONTAIN THE FOLLOWING TERMS AND CONDITIONS, WHICH BIDDER HEREBY ACKNOWLEDGES, AND TO WHICH BIDDER AGREES BY SUBMITTING A BID:

1. Standard Terms and Conditions

- A. Taxpayer Identification: Bidders must provide the County with a current W-9 before any goods or services can be procured from the Bidder.
- B. Governing Law and Venue: All Bids submitted in response to this solicitation and any resulting contract shall be governed by, and construed in accordance with the laws and court decisions of the State of Texas. Any legal or equitable actions arising from this request for Bids or any resulting contract shall be brought before an appropriate court located in the Bastrop County.
- C. Resolution of Program Non-compliance and Disallowed Costs: In the event of any dispute, claim, question, or disagreement arising from or relating to this agreement, or the breach thereof, including determination of responsibility for any costs disallowed as a result of non-compliance with federal, state or TxCDBG program requirements, the parties hereto shall use their best efforts to settle the dispute, claim, question or disagreement. To this effect, the parties shall consult and negotiate with each other in good faith within 30 days of receipt of a written notice of the dispute or invitation to negotiate, and attempt to reach a just and equitable solution satisfactory to both parties. If the matter is not resolved by negotiation within 30 days of receipt of written notice or invitation to negotiate, the parties agree first to try in good faith to settle the matter by mediation administered by the American Arbitration Association under its Commercial Mediation Procedures before resorting to arbitration, litigation, or some other dispute resolution procedure. The parties may enter into a written amendment to this Agreement and choose a mediator that is not affiliated with the American Arbitration Association. The parties shall bear the costs of such mediation equally. [This section may also provide for the qualifications of the mediator(s), the locale of meetings, time limits or any other item of concern to the parties. If the matter is not resolved through such mediation within 60 days of the initiation of that procedure, either party may proceed to file suit.
- D. Termination for Cause: The occurrence of any one or more of the following events will justify termination of the contract by the County for cause:
 - i. The successful Bidder fails to perform in accordance with the provisions of these specifications; or

- ii. The successful Bidder violates any of the provisions of these specifications; or
- iii. The successful Bidder disregards laws or regulations of any public body having jurisdiction; or
- iv. The successful Bidder transfers, assigns, or conveys any or all of its obligations or duties under the contract to another without written consent of the County.
- v. If one or more of the events identified in Subparagraphs I (i) through (iv) occurs, the County may, terminate the contract by giving the successful Bidder seven (7) Calendar days written notice. In such case, the successful Bidder shall only be entitled to receive payment for goods and services provided before the effective date of termination. The successful Bidder shall not receive any payment on account of loss of anticipated profits or revenue or other economic loss resulting from such termination.
- vi. When the contract has been so terminated by the County, such termination shall not affect any rights or remedies of the County then existing or which may thereafter accrue.

A "Termination for Cause" clause will be added to selected Bidder's contract with Bastrop County.

- E. Termination for Convenience: This contract may be cancelled or terminated at any time by giving vendor thirty (30) days written notice. Vendor may be entitled to payment for services actually performed; to the extent said services are satisfactory.

A "Termination for Convenience" clause will be added to selected Bidder's contract with Bastrop County.

- F. Force Majeure: To the extent that either party to this Contract shall be wholly or partially prevented from the performance within the term specified of any obligation or duty placed on such party by reason of or through strikes, stoppage of labor, riot, fire, flood, acts of war, insurrection, accident, order of any court, act of God, or specific cause reasonably beyond the party's control and not attributable to its neglect or nonfeasance, in such event, the time for the performance of such obligation or duty shall be suspended until such disability to perform is removed. Determination of force majeure shall rest solely with Bastrop County.

- G. Compliance with the Byrd Anti-Lobbying Amendment (31 U.S.C. 1352): Contractors that apply or bid for an award of \$100,000 or more must file the required certification. Each tier certifies to the tier above that it will not and has not used Federal appropriated funds to pay any person or organization for influencing or attempting to influence an officer or employee of any agency, a member of Congress, officer or employee of Congress, or an employee of a member of Congress in connection with obtaining any Federal contract, grant or any other award covered by 31 U.S.C. 1352. Each tier must also disclose any lobbying with non-Federal funds that takes place in connection with obtaining any Federal award. Such disclosures are forwarded from tier to tier up to the non-Federal award.

- H. Contract Work Hours and Safety Standards Act (40 U.S.C. 3701-3708): Where applicable, all contracts awarded by the non-Federal entity in excess of \$100,000 that involve the employment of mechanics or laborers must include a provision for compliance with 40 U.S.C. 3702 and 3704, as supplemented by Department of Labor regulations (29 CFR Part 5). Under 40 U.S.C. 3702 of the Act, each contractor must be required to compute the wages of every mechanic and laborer on the basis of a standard work week of 40 hours. Work in excess of the standard work week is permissible provided that the worker is compensated at a rate of not less than one and a half times the basic rate of pay for all hours worked in excess of 40 hours in the work week. The requirements of 40 U.S.C. 3704 are applicable to construction work and provide that no laborer or mechanic must be required to work in surroundings or under working conditions which are unsanitary, hazardous or dangerous. These requirements do not apply to the purchases of supplies or materials or articles ordinarily available on the open market, or contracts for transportation or transmission of intelligence.

- I. Clean Air Act (42 U.S.C. 7401-7671g.) and the Federal Water Pollution Control Act (33 U.S.C. 1251-1387):

Contracts and subgrants of amounts in excess of \$150,000 must contain a provision that requires the non-Federal award to agree to comply with all applicable standards, orders or regulations issued pursuant to the Clean Air Act (42 U.S.C. 7401-7671q) and the Federal Water Pollution Control Act as amended (33 U.S.C 1251-1387). Violations must be reported to the Federal awarding agency and the Regional Office of the Environmental Protection Agency (EPA).

J. Affirmative Action/EOE: Bastrop County is an Affirmative Action/Equal Opportunity Employer and strives to attain goals for of the Housing and Urban Development Act of 1968 (12U.S.C. 1701u) as amended. See Appendix F - Bastrop County Section 3 Resolution. During the performance of an awarded contract, the contractor agrees as follows:

1. The contractor will not discriminate against any employee or applicant for employment because of race, color, religion, sex, sexual orientation, gender identity, or national origin. The contractor will take affirmative action to ensure that applicants are employed, and that employees are treated during employment without regard to their race, color, religion, sex, sexual orientation, gender identity, or national origin. Such action shall include, but not be limited to the following: Employment, upgrading, demotion, or transfer; recruitment or recruitment advertising; layoff or termination; rates of pay or other forms of compensation; and selection for training, including apprenticeship. The contractor agrees to post in conspicuous places. Available to employees and applicants for employment, notices to be provided setting forth the provisions of this nondiscrimination clause.
2. The contractor will, in all solicitations or advertisements for employees placed by or on behalf of the contractor, state that all qualified applicants will receive considerations for employment without regard to race, color, religion, sex, sexual orientation, gender identity, or national origin.
3. The Contractor will not discourage or in any other manner discriminate against any employee or applicant for employment because such employee or applicant has inquired about, discussed, or disclosed the compensation of the employee or applicant or another employee or applicant. This Provision shall not apply to instances in which an employee who has access to the compensation information of other employees or applicants as a part of such employee's essential job functions discloses the compensation of such other employees or applicants to individuals who do not otherwise have access to such information, unless such disclosure is in response to a formal complaint or charge, in furtherance of an investigation, proceeding, hearing, or action, including an investigation conducted by the employer, or is consistent with the contractor's legal duty to furnish information.
4. The contractor will send to each labor union or representative of workers with which he has a collective bargaining agreement or other contract or understanding, a notice to be provided advising the said labor union or workers' representatives of the contractor's commitments under this section, and shall post copies of the notice in conspicuous places available to employees and applicants for employment.
5. The contractor will comply with all provisions of Executive Order 11246 of September 24, 1965, and of the rules, regulations, and relevant orders of the Secretary of Labor.
6. The contractor will furnish all information and reports required by Executive Order 11246 of September 24, 1965, and by rules, regulations, and orders of the Secretary of Labor, or pursuant thereto, and will permit access to his books, records, and accounts by the administering agency and the Secretary of Labor for purposes of investigation to ascertain compliance with such rules, regulations and orders.
7. In the event of the contractor's noncompliance with the nondiscrimination clauses of this contract or with any of the said rules, regulations, or orders, this contract may be canceled, terminated, or suspended in whole or in part and the contractor may be declared ineligible for further Government contracts or federally assisted construction contracts in accordance with procedures authorized in

Executive Order 11246 of September 24, 1965, and such other sanctions may be imposed and remedies invoked as provided in Executive Order 11246 of September 24, 1965, or by rule, regulation, or order of the Secretary of Labor, or as otherwise provided by law.

8. The contractor will include the portion of the sentence immediately preceding paragraph (1) and the provisions of paragraphs (1) through (7) in every subcontract or purchase order unless exempted by rules, regulations, or orders of the Secretary of Labor issued pursuant to section 204 of Executive Order 11246 of September 24, 1965, so that such provisions will be binding upon each subcontractor or vendor. The contractor will take such action with respect to any subcontract or purchase order as the administering agency may direct as a means of enforcing such provisions, including sanctions for noncompliance: Provided, however, that in the event a contractor becomes involved in, or is threatened with litigation with a subcontractor or vendor as a result of such direction by the administering agency the contractor may request the United States to enter into such litigation to protect the interests of the United States.
9. The applicant further agrees that it will be bound by the above equal opportunity clause with respect to its own employment practices when it participates in federally assisted construction work: Provided, That if the applicant so participating is a State or local government, the above equal opportunity clause is not applicable to any agency, instrumentality or subdivision of such government which does not participate in work on or under the contract.
10. The applicant agrees that it will assist and cooperate actively with the administering agency and the Secretary of Labor in obtaining the compliance of contractors and subcontractors with the equal opportunity clause and the rules, regulations, and relevant orders of the Secretary of Labor, that it will furnish the administering agency and the Secretary of Labor such information as they may require for the supervision of such compliance, and that it will otherwise assist the administering agency in the discharge of the agency's primary responsibility for securing compliance.
11. The applicant further agrees that it will refrain from entering into any contract or contract modification subject to Executive Order 11246 of September 24, 1965, with a contractor debarred from, or who has not demonstrated eligibility for, Government contracts and federally assisted construction contracts pursuant to the Executive order and will carry out such sanctions and penalties for violation of the equal opportunity clause as may be imposed upon contractors and subcontractors by the administering agency or the Secretary of Labor pursuant to Part II, Subpart D of the Executive order. In addition, the applicant agrees that if it fails or refuses to comply with these undertakings, the administering agency may take any or all of the following actions: Cancel, terminate, or suspend in whole or in part this grant (contract, loan, insurance, guarantee); refrain from extending any further assistance to the applicant under the program with respect to which the failure or refund occurred until satisfactory assurance of future compliance has been received from such applicant; and refer the case to the Department of Justice for appropriate legal proceedings.
12. Subcontracts. Each nonexempt prime contractor or subcontractor shall include the equal opportunity clause in each of its nonexempt subcontracts.

K. Payment Terms: Unless otherwise specified in the Scope of Services or otherwise agreed to in writing by Bastrop County, payment terms for the County are Net 30 days upon receipt of invoice after receipt of goods or services. A 5% retainage will be held from each invoice until the completion of the project. Pay applications must be submitted to the Bastrop County Purchasing Department for approval and processing for payment. Bastrop County will pay based on percentage of completion at the time of pay application submission pending verification from the Bastrop County Road and Bridge Precinct Commissioner. Final approval will be based on an inspection of the project for verification of compliance with all aspects of the scope of work listed within Appendix A of this RFB. The work performed in accordance with this contract shall be paid for using unit

pricing (per ton of material to include all other cost associated with completing the project). This price is full compensation for all task listed in the bid submitted by the vendor and must include all necessary fees, charges and bonds needed to complete this work. Bastrop County will NOT pay any fees to the vendor other than the agreed upon unit price. Contractor shall submit written proof of the quantity of material used with each invoice for verification of invoice cost.

- L. Liquidated Damages: Should the **CONTRACTOR** fail to complete the requirements set forth in the scope of work, Bastrop County will suffer damage. The amount of damage suffered by Bastrop County is difficult, if not impossible, to determine at this time. Therefore, the **CONTRACTOR** shall pay Bastrop County, as liquidated damages, the following:
 - The **CONTRACTOR** shall pay Bastrop County, liquidated damages, \$1500 per incident where the **CONTRACTOR** fails to repair damages that are caused by the **CONTRACTOR** and/or sub-contractor(s). Application of liquidated damaged does not release the **CONTRACTOR** from the responsibility of resolving or repairing
 - The amount specified above are mutually agreed upon as reasonable and the proper amount of liquidated damages Bastrop County would suffer in the aforementioned examples.
- M. Warranty of Products and Services: All products or services furnished under this contract shall be warranted to be merchantable and good quality and fit for the purposes intended as described in this bid, to the satisfaction of County and in accordance with the manufacturers specifications, terms, and conditions of the scope of work (Appendix A), and all services performed shall be warranted to be of a good and workmanlike quality, in addition to, and not in lieu of, any other express written warranties provided.
- N. Payment and Performance Bonds: Payment and Performance bonds shall be required and issued for this contract should the total bid price reach the State of Texas threshold for public works projects. The contractor agrees that within ten (10) days after a work order is issued and sent to them by Bastrop County, a Payment Bond will be executed and delivered to Bastrop County for the amount of one hundred percent (100%) of the estimated contract total, should the contract total meet and/or exceed twenty-five thousand dollars (\$25,000). A Performance bond in an amount of one hundred percent (100%) of the estimated contract price should also be executed and delivered to Bastrop County should the contract amount meet and/or exceed one hundred thousand dollars (\$100,000). The Performance and Payment Bond must be maintained throughout the contract execution period. At the completion of all work, the Payment and Performance Bond shall be released. Cost of all bonds must be included in the bid price. Payment for services will not be made until receipt of all required bonds has been made to Bastrop County. **NO WORK CAN BEGIN ON A PROJECT UNTIL ALL NECESSARY BONDS HAVE BEEN RECEIVED BY BASTROP COUNTY.**
- O. Funding: State of Texas statutes prohibit the obligation and expenditure of public funds beyond the fiscal year for which a budget has been approved. Orders or other obligations that may arise beyond the end of the current fiscal year shall be subject to approval of budget funds.
- P. Taxes: The County is exempt from all federal excise taxes and all state and local sales and use taxes. If such taxes are listed on a Bidder's invoice, they will not be paid.
- Q. Insurance: The Bidder, consistent with its status as an independent contractor, shall carry, and shall require any of its subcontractors to carry, at least the following insurance in such form, with such companies, and in such amounts (unless otherwise specified) as County may require:
 1. Worker's Compensation and Employer's Liability insurance, including All States Endorsement, to the extent required by federal law and complying with the laws of the State of Texas;
 2. Commercial General Liability insurance, including Blanket Contractual Liability, Broad Form Property

Damage, Personal Injury, Completed Operations/Products Liability, Premises Liability, Medical Payments, Interest of Employees as additional insureds, and Broad Form General Liability Endorsements, for at least One Million Dollars (\$1,000,000) Combined Single Limit Bodily Injury and Property Damage on an occurrence basis;

3. Comprehensive Automobile Liability insurance covering all owned, non-owned or hired automobiles to be used by the Contractor, with coverage for at least One Million Dollars (\$1,000,000) Combined Single Limit Bodily Injury and Property Damage.

Contractor shall submit proof to Bastrop County that said contractor has the ability to meet all insurance requirements listed above.

- S. Indemnification: Bidder agrees to defend, indemnify and hold harmless the County of Bastrop, all of its officers, agents, employees, appointees and volunteers from and against all claims, actions, suits, demands, proceedings, costs, damages and liabilities, including reasonable attorneys' fees, court costs, related expenses for personal injury (including death), property damage or other harm for which recovery of damages is sought, suffered by any person or persons, that may arise out of or be occasioned by Bidder's breach of any of the terms or provisions of any contract awarded as a result of this solicitation, or by any negligent or strictly liable act or omission of the Bidder, its officers, agents, employees, or subcontractors, in the performance of an awarded contract; except that the indemnity provided for in this paragraph shall not apply to any liability resulting from the sole negligence or fault of the County, its officers, agents or employees, and in the event of joint and concurrent negligence or fault of the Bidder and County, responsibility and indemnity, if any, shall be apportioned comparatively in accordance with the laws of the State of Texas, without waiving any governmental immunity available to the County under Texas law and without waiving any defenses of the parties under Texas law. The provisions of this paragraph are solely for the benefit of the parties hereto and are not intended to create or grant any rights, contractual or otherwise, to any other person or entity.

****THE REMAINDER OF THIS PAGE LEFT BLANK INTENTIONALLY****

IN SUBMITTING A RESPONSE TO THIS RFB, THE RESPONDENT AGREES THAT IT WAIVES ANY CLAIMS IT HAS OR MAY HAVE AGAINST THE COUNTY, THE COUNTY'S EMPLOYEES, OFFICERS, AGENTS, REPRESENTATIVES, AND THE MEMBERS OF THE COUNTY'S GOVERNING BODY IN CONNECTION WITH OR ARISING OUT OF THIS RFB, INCLUDING, THE ADMINISTRATION OF THE RFB, THE BASIS FOR SELECTION, THE EVALUATIONS OF THE RESPONSES, THE METHOD USED FOR SELECTION, AND ANY DISCLOSURE OF INFORMATION REGARDING THE RESPONSES OR EVALUATIONS. THE SUBMISSION OF A BID CONSTITUTES THE ACCEPTANCE BY THE RESPONDENT OF THE EVALUATION TECHNIQUE DESCRIBED IN THIS RFB. THE PERSON SIGNING ON BEHALF OF BIDDER CERTIFIES THAT THE SIGNER HAS AUTHORITY TO SUBMIT THE BID ON BEHALF OF THE BIDDER AND TO BIND THE BIDDER TO ANY RESULTING CONTRACT

I ACKNOWLEDGE THAT I HAVE READ AND UNDERSTAND ALL REQUIREMENTS SETFORTH IN THIS REQUEST FOR BIDS:

Authorized Signatory for Contractor:

Name of Company:

Date:

CONFLICT OF INTEREST QUESTIONNAIRE

For vendor doing business with local governmental entity

FORM CIQ

This questionnaire reflects changes made to the law by H.B. 23, 84th Leg., Regular Session.

This questionnaire is being filed in accordance with Chapter 176, Local Government Code, by a vendor who has a business relationship as defined by Section 176.001(1-a) with a local governmental entity and the vendor meets requirements under Section 176.006(a).

By law this questionnaire must be filed with the records administrator of the local governmental entity not later than the 7th business day after the date the vendor becomes aware of facts that require the statement to be filed. See Section 176.006(a-1), Local Government Code.

A vendor commits an offense if the vendor knowingly violates Section 176.006, Local Government Code. An offense under this section is a misdemeanor.

OFFICE USE ONLY

Date Received

1 Name of vendor who has a business relationship with local governmental entity.

2 Check this box if you are filing an update to a previously filed questionnaire. (The law requires that you file an updated completed questionnaire with the appropriate filing authority not later than the 7th business day after the date on which you became aware that the originally filed questionnaire was incomplete or inaccurate.)

3 Name of local government officer about whom the information is being disclosed.

Name of Officer

4 Describe each employment or other business relationship with the local government officer, or a family member of the officer, as described by Section 176.003(a)(2)(A). Also describe any family relationship with the local government officer. Complete subparts A and B for each employment or business relationship described. Attach additional pages to this Form CIQ as necessary.

A. Is the local government officer or a family member of the officer receiving or likely to receive taxable income, other than investment income, from the vendor?

Yes No

B. Is the vendor receiving or likely to receive taxable income, other than investment income, from or at the direction of the local government officer or a family member of the officer AND the taxable income is not received from the local governmental entity?

Yes No

5 Describe each employment or business relationship that the vendor named in Section 1 maintains with a corporation or other business entity with respect to which the local government officer serves as an officer or director, or holds an ownership interest of one percent or more.

6 Check this box if the vendor has given the local government officer or a family member of the officer one or more gifts as described in Section 176.003(a)(2)(B), excluding gifts described in Section 176.003(a-1).

7

Signature of vendor doing business with the governmental entity

Date

CONFLICT OF INTEREST QUESTIONNAIRE

For vendor doing business with local governmental entity

A complete copy of Chapter 176 of the Local Government Code may be found at <http://www.statutes.legis.state.tx.us/Docs/LG/htm/LG.176.htm>. For easy reference, below are some of the sections cited on this form.

Local Government Code § 176.001(1-a): "Business relationship" means a connection between two or more parties based on commercial activity of one of the parties. The term does not include a connection based on:

- (A) a transaction that is subject to rate or fee regulation by a federal, state, or local governmental entity or an agency of a federal, state, or local governmental entity;
- (B) a transaction conducted at a price and subject to terms available to the public; or
- (C) a purchase or lease of goods or services from a person that is chartered by a state or federal agency and that is subject to regular examination by, and reporting to, that agency.

Local Government Code § 176.003(a)(2)(A) and (B):

(a) A local government officer shall file a conflicts disclosure statement with respect to a vendor if:

(2) the vendor:

(A) has an employment or other business relationship with the local government officer or a family member of the officer that results in the officer or family member receiving taxable income, other than investment income, that exceeds \$2,500 during the 12-month period preceding the date that the officer becomes aware that

(i) a contract between the local governmental entity and vendor has been executed;
or

(ii) the local governmental entity is considering entering into a contract with the vendor;

(B) has given to the local government officer or a family member of the officer one or more gifts that have an aggregate value of more than \$100 in the 12-month period preceding the date the officer becomes aware that:

(i) a contract between the local governmental entity and vendor has been executed; or
(ii) the local governmental entity is considering entering into a contract with the vendor.

Local Government Code § 176.006(a) and (a-1)

(a) A vendor shall file a completed conflict of interest questionnaire if the vendor has a business relationship with a local governmental entity and:

(1) has an employment or other business relationship with a local government officer of that local governmental entity, or a family member of the officer, described by Section 176.003(a)(2)(A);

(2) has given a local government officer of that local governmental entity, or a family member of the officer, one or more gifts with the aggregate value specified by Section 176.003(a)(2)(B), excluding any gift described by Section 176.003(a-1); or

(3) has a family relationship with a local government officer of that local governmental entity.

(a-1) The completed conflict of interest questionnaire must be filed with the appropriate records administrator not later than the seventh business day after the later of:

(1) the date that the vendor:

(A) begins discussions or negotiations to enter into a contract with the local governmental entity; or

(B) submits to the local governmental entity an application, response to a request for proposals or bids, correspondence, or another writing related to a potential contract with the local governmental entity; or

(2) the date the vendor becomes aware:

(A) of an employment or other business relationship with a local government officer, or a family member of the officer, described by Subsection (a);

(B) that the vendor has given one or more gifts described by Subsection (a); or

(C) of a family relationship with a local government officer.

Implementation of House Bill 1295

Certificate of Interested Parties (Form 1295):

In 2015, the Texas Legislature adopted [House Bill 1295](#), which added [section 2252.908](#) of the Government Code. The law states that a governmental entity or state agency may not enter into certain contracts with a business entity unless the business entity submits a disclosure of interested parties to the governmental entity or state agency at the time the business entity submits the signed contract to the governmental entity or state agency.

The law applies (with a few exceptions) only to a contract between a business entity and a governmental entity or state agency that either (1) requires an action or vote by the governing body of the entity or agency before the contract may be signed or (2) has a value of at least \$1 million. The disclosure requirement applies to a contract entered into on or after January 1, 2016.

Changed or Amended Contracts:

Form 1295 is only required for a change made to an existing contract in certain circumstances: (1) if a Form 1295 was not filed for the existing contract, then a filing is only required if the changed contract either requires an action or vote by the governing body or the value of the changed contract is at least \$1 million; or (2) if a Form 1295 was filed for the existing contract, then another filing is only required for the changed contract if there is a change to the information disclosed in the Form 1295, the changed contract requires an action or vote by the governing body, or the value of the changed contract increases by at least \$1 million.

As required by law, the Commission adopted the Certificate of Interested Parties form (Form 1295) on October 5, 2015. The Commission also adopted rules ([Chapter 46](#)) to implement the law. The Commission does not have any additional authority to enforce or interpret [section 2252.908](#) of the Government Code.

Filing Process:

A business entity must use the [Form 1295 filing application](#) the Commission created to enter the required information on Form 1295 and print a copy of the completed form. Once entered into the filing application, the completed form will include a unique certification number, called a “certification of filing.”

An authorized agent of the business entity must sign the printed copy of the form affirming under the penalty of perjury that the completed form is true and correct.

The completed, printed, and signed Form 1295 bearing the unique certification of filing number must be filed with the governmental body or state agency with which the business entity is entering into the contract.

Acknowledgement by State Agency or Governmental Entity:

The governmental entity or state agency must acknowledge receipt of the filed Form 1295 with the certification of filing, using the Commission’s filing application, not later than the 30th day after the date the governing body or state agency receives the Form 1295. The Commission will post the completed Form 1295 to its website within seven business days after the governmental entity or state agency acknowledges receipt of the form.

Changes to Form 1295

Changes to the law requiring certain businesses to file a Form 1295 are in effect for contracts entered into or amended on or after January 1, 2018. The changes exempt businesses from filing a Form 1295 for certain types of contracts and replace the need for a completed Form 1295 to be notarized. Instead, the person filing a 1295 needs to complete an “unsworn declaration.”

What type of contracts are exempt from the Form 1295 filing requirement under the amended law?

The amended law adds to the list of types of contract exempt from the Form 1295 filing requirement. A completed Form 1295 is not required for:

- A sponsored research contract of an institution of higher education;
- An interagency contract of a state agency or an institution of higher education;

- A contract related to health and human services if: o the value of the contract cannot be determined at the time the contract is executed; and o any qualified vendor is eligible for the contract;
- A contract with a publicly traded business entity, including a wholly owned subsidiary of the business entity;*
- A contract with an electric utility, as that term is defined by Section 31.002, Utilities Code;* or
- A contract with a gas utility, as that term is defined by Section 121.001, Utilities Code.*

The newly exempt contract types are marked with an asterisk.

Why do I need to include my date of birth and address when I sign Form 1295? Was this always the case?

In 2017, the legislature amended the law to require Form 1295 to include an “unsworn declaration” which includes, among other things, the date of birth and address of the authorized representative signing the form. The change in the law applies to contracts entered into, renewed, or amended on or after January 1, 2018. The unsworn declaration, including the date of birth and address of the signatory, replaces the notary requirement that applied to contracts entered into before January 1, 2018.

Will my date of birth and address appear on the TEC’s website when I file the form?

No. The TEC filing application does not capture the date of birth or street address of the signatory and it will not appear on forms that are filed using the TEC filing application. Although the TEC does not capture the date of birth and street address of the signatory, the contracting state agency or governmental agency will have a physical copy of the form that includes the date of birth and address of the signatory. The TEC cannot answer whether the contracting state agency or governmental agency may release such information. Questions regarding the Texas Public Information Act may be directed to the Office of the Attorney General. See also *Paxton v. City of Dall.*, No. 03-13-00546-CV, 2015 Tex. App. LEXIS 5228, at *10-11 (App.—Austin May 22, 2015) (mem. op.) (pet. denied) (available here).

CERTIFICATE OF INTERESTED PARTIES

FORM 1295

OFFICE USE ONLY

Complete Nos. 1 - 4 and 6 if there are interested parties.
 Complete Nos. 1, 2, 3, 5, and 6 if there are no interested parties.

1 Name of business entity filing form, and the city, state and country of the business entity's place of business.

2 Name of governmental entity or state agency that is a party to the contract for which the form is being filed.

3 Provide the identification number used by the governmental entity or state agency to track or identify the contract, and provide a description of the services, goods, or other property to be provided under the contract.

| 4 Name of Interested Party | City, State, Country (place of business) | Nature of Interest (check applicable) | |
|-------------------------------|---|---------------------------------------|--------------|
| | | Controlling | Intermediary |
| | | | |
| | | | |
| | | | |
| | | | |
| | | | |
| | | | |
| | | | |
| | | | |

5 Check only if there is NO Interested Party.

6 UNSWORN DECLARATION

My name is _____, and my date of birth is _____.

My address is _____, _____, _____, _____, _____.
(street) (city) (state) (zip code) (country)

I declare under penalty of perjury that the foregoing is true and correct.

Executed in _____ County, State of _____, on the _____ day of _____, 20____.
(month) (year)

 Signature of authorized agent of contracting business entity
 (Declarant)

ADD ADDITIONAL PAGES AS NECESSARY

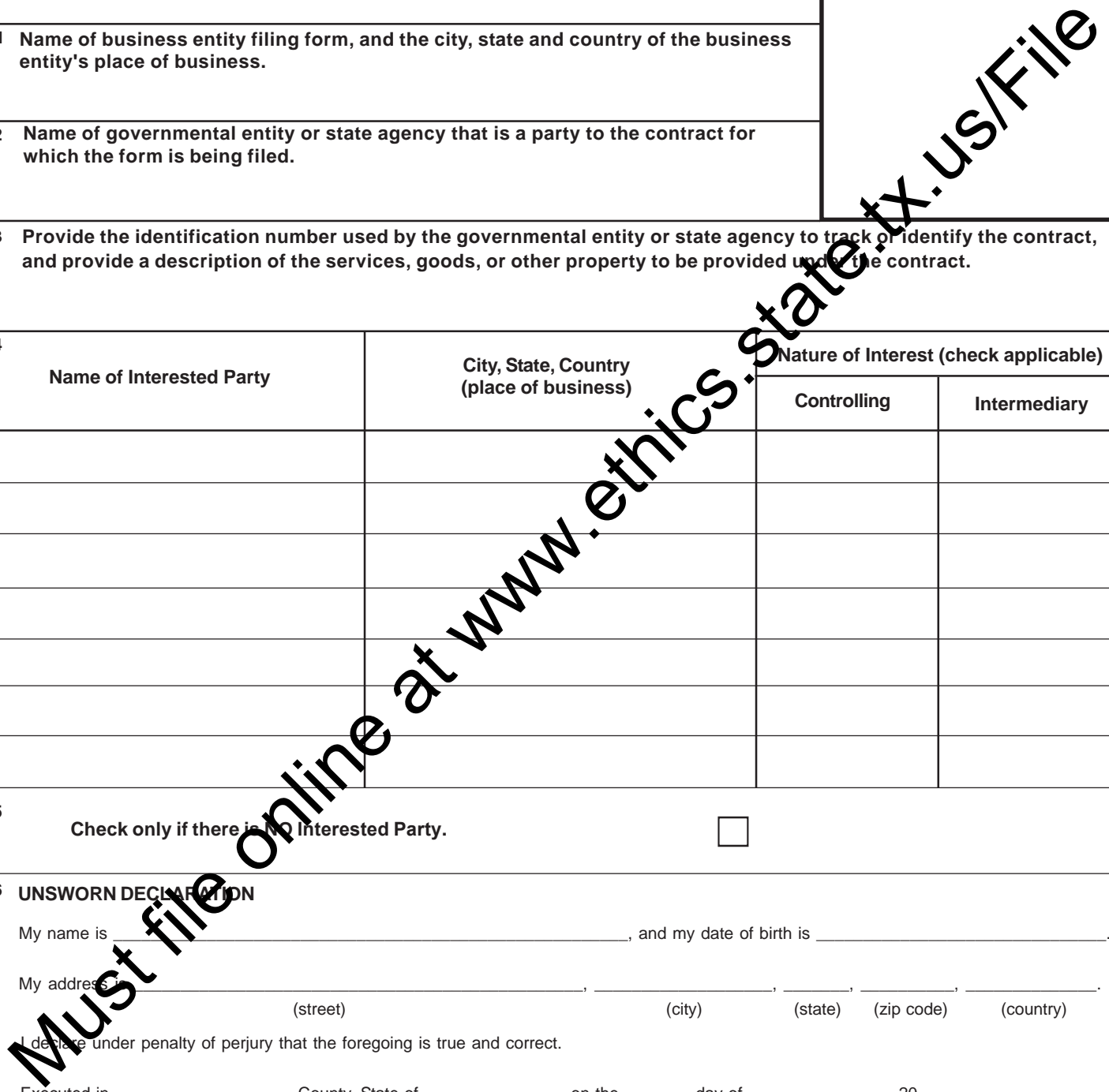

House Bill 89 VERIFICATION

I, _____, the undersigned representative of
_____ (hereafter referred to as company)

being an adult over the age of eighteen (18) years of age, after being duly sworn by the undersigned notary, do hereby depose and verify under oath that the company named-
above, under the provisions of Subtitle F, Title 10, Government Code Chapter 2270::

- 1. Does not boycott Israel currently; and
- 2. Will not boycott Israel during the term of the contract the above-named
Company, business or individual with Bastrop County, Texas.

Pursuant to Section 2270.001, Texas Government Code:

- 1. *“Boycott Israel” means refusing to deal with, terminating business activities with, or otherwise taking any action that is intended to penalize, inflict economic harm on, or limit commercial relations specifically with Israel, or with a person or entity doing business in Israel or in an Israeli-controlled territory, but does not include an action made for ordinary business purposes; and*
- 2. *“Company” means a for-profit sole proprietorship, organization, association, corporation, partnership, joint venture, limited partnership, limited liability partnership, or any limited liability company, including a wholly owned subsidiary, majority-owned subsidiary, parent company or affiliate of those entities or business associations that exist to make a profit.*

DATE

SIGNATURE OF COMPANY REPRESENTATIVE

ON THIS THE ____ day of _____, 20____, personally
appeared _____, the above-named
person, who after by me being duly sworn, did swear and confirm that the above
is true and correct.

NOTARY SEAL

NOTARY SIGNATURE

RESOLUTION

AN AMENDMENT TO A RESOLUTION OF THE COMMISSIONERS' COURT OF THE COUNTY OF BASTROP, TEXAS DATED APRIL 22, 2013 AUTHORIZING THE COUNTY JUDGE OR HIS DESIGNEE TO IMPLEMENT A SECTION 3 PROGRAM, WHICH TO THE GREATEST EXTENT FEASIBLE, WILL PROVIDE JOB TRAINING, EMPLOYMENT, AND CONTRACTING OPPORTUNITIES FOR SECTION 3 BUSINESSES OF THE AREA IN WHICH THE TEXAS COMMUNITY DEVELOPMENT BLOCK GRANT (TXCDBG) PROGRAM/PROJECT IS BEING CARRIED OUT.

WHEREAS; Section 3 of the Housing and Urban Development Act of 1968 (12 U.S.C. 1701u), as amended, requires that Bastrop County ensure that training, employment and other economic opportunities generated by certain HUD financial assistance for housing and Community Development Programs shall, to the greatest extent feasible, be given to low- and very low- income persons, particularly those who are recipients of governmental assistance for housing, and to businesses that provide economic opportunities for these persons, and

WHEREAS; the County of Bastrop has been grant funded for various projects under the Texas Community Development Block Grant Program (CDBG), and

WHEREAS; the County of Bastrop is required to adopt a Section 3 Program as part of the requirements of the grant(s), and

WHEREAS; a Section 3 resident is defined as a public housing resident and/or a low to very-low income person who lives in an area where a CDBG assisted project is located, and

WHEREAS; a Section 3 business is defined as a business that has a Section 3 resident own at least 51 percent or more of the business or have at least 30 percent of the permanent, full-time employees of the business identified as Section 3 residents, and

WHEREAS; the County of Bastrop will strive to attain goals for compliance with Section 3 regulations;

NOW THEREFORE BE IT RESOLVED BY THE COMMISSIONERS' COURT OF BASTROP COUNTY, TEXAS:

1. The COMMISSIONERS' COURT has reviewed and hereby agrees to Implement the following steps, which, to the greatest extent feasible, will provide job training, employment and contracting opportunities for Section 3 residents and Section 3 businesses of the area in which the CDBG program/project is being carried out.
2. The COMMISSIONERS' COURT hereby agrees to strive to attain goals for compliance with Section 3 regulations by increasing opportunities for employment and contracting with Section 3 residents and businesses where feasible.
3. The COMMISSIONERS' COURT hereby agrees to assign duties related to implementation of this plan to the designated Section 504 and Equal

Opportunity/Fair Housing Officer.

4. The COMMISSIONERS COURT hereby delegates to the County Judge the authority to implement measures that comply with the Section 3 goals and to assign duties for carrying out these measures to County personnel and/or third party consultant(s).
5. The COMMISSIONERS' COURT hereby agrees that the County will Notify Section 3 residents and business concerns of potential new employment and contracting opportunities as they are triggered by CDBG grant awards through the use of: public notices; bidding advertisements and bid documents; local advertising media including public signage; and Including Section 3 clauses In all CDBG solicitations and contracts.
6. The COMMISSIONERS' COURT hereby agrees to maintain a list of those businesses that have identified themselves as Section 3 businesses for utilization in CDBG funded procurements, notify those businesses of pending contractual opportunities, and make this list available for general Grant Recipient procurement needs.
7. The COMMISSIONERS' COURT hereby agrees to maintain a list of those persons who have identified themselves as Section 3 residents and contact those persons when hiring/training opportunities are available through either the Grant Recipient or contractors.
8. The COMMISSIONERS' COURT hereby agrees to require that all Prime contractors and subcontractors on CDBG projects commit to this plan as part of their contract work; monitor the contractors' performance with respect to meeting Section 3 requirements, and require that they submit reports as may be required to the Bastrop County.
9. The COMMISSIONERS' COURT hereby agrees to submit reports as required by the CDBG program regarding contracting with Section 3 businesses and/or employment as they occur; and submit reports within 20 days of calendar year end which identify and quantify Section 3 businesses and employees.
10. The COMMISSIONERS' COURT hereby agrees to maintain records for the CDBG program, including copies of correspondence, memoranda, etc., which document all actions taken to comply with Section 3 regulations.
11. The COMMISSIONERS COURT hereby orders that the following procedures will be implemented to assure compliance with the intent of this Resolution:
 - a. The County Judge will appoint one or more county employees to coordinate the Section 3 responsibilities for compliance and monitoring of all Section 3 activities for CDBG Disaster Recovery Program funded projects. The County may also engage the services of third party consultants to assist.
 - b. Preference shall be awarded to Section 3 Business Concerns according to the following system:

- 1) Where the Section 3 Covered Contract is to be awarded to the lowest responsible bidder, then to the extent permitted by applicable law, the contract, if awarded, shall be awarded to the qualified Section 3 Business Concern with the lowest bid, if it is reasonable and no more than 10 percent higher than the lowest bid from any qualified source. If no bid by a qualified Section 3 Business Concern is within 10 percent of the lowest bid from any qualified source, then any contract award shall be made to the source with the lowest bid.
 - 2) Where the Section 3 Covered Contract is to be awarded based on factors in addition to price, a request for proposals shall be issued by developing the particulars of the solicitation, including a rating system for the assignment of points to evaluate the merits of each response. The solicitation shall identify all factors to be considered, including price or cost. The rating system shall provide for a range of 15 to 25 percent of the total number of available rating points to be set aside for the award to respondents who have demonstrated a commitment to meet Section 3 requirements set out below in Section 11 c. If an award is made, the contract shall be awarded to the responsible firm whose proposal provides the best value to the County, considering price and all other factors specified in the rating system.
- c. In responding to a solicitation (Request for Bids, Request for Proposals, etc.) for a Section 3 covered contract, all contractors and subcontractors are required to comply with the Bastrop County Section 3 Plan. The contractor and the County will review the Section 3 Plan procedures and applicable forms that the contractor will use to report progress toward Section 3 goals. The Section 3 requirements also apply to contracts with consultants for a Section 3 covered contract.
 - d. All general contractors and/or sub-contractors shall set a goal that 30 percent of new hires will be Section 3 residents. Contractors should provide job opportunities for skilled and unskilled workers. All Contractors and Subcontractors will be required to post all new hire opportunities with the local Workforce Solutions Center, WorkinTexas.com, and Bastrop County.
 - e. Bastrop County will analyze and evaluate the contractor's compliance with requirements and obligations set forth in the contract. In the event that a review reveals a contractor has not complied with Section 3 requirements, the County will undertake efforts to help the contractor achieve compliance.
 - f. The contractor and or sub-contractor shall submit monthly

reports regarding the status of each Section 3 participant. An annual report will also be requested from each contractor and/or subcontractor in connection to the performance of each project. This Annual Report will document the efforts and success of all Section 3 participants and subcontractors working under the general contractor, in reaching the percentage goals for employment and business opportunities established in these policies.

- g. The contractor and/or subcontractor shall submit weekly-certified payroll reports to Bastrop County. This report shall be submitted weekly and clearly identify Section 3 Hires.
- h. Bastrop County or its consultant will conduct periodic site visits to the worksite. The Coordinator shall visibly notice each Section 3 hire on site. The general contractor will sign a monitoring form verifying that a Section 3 worker is present.
- i. Complaints regarding the County's Section 3 Program must be submitted in writing. All complaints must include the complainant's name, address, telephone number, and a brief narrative detailing the complaint, including but not limited to, the date of the alleged violation and the date the alleged violation was discovered. Complaints shall be filed within 30 calendar days after the complainant becomes aware of any alleged violation. Bastrop County will investigate every complaint. All parties involved will have the opportunity to submit testimony and/or evidence as may be available and relevant to the complaint, and a written determination will be issued within 30 days after the filing of the complaint. Filing a complaint does not terminate a contractor's Section 3 requirements. Contractors remain accountable for fulfilling the agreed upon Section 3 requirements.

As officers and representatives of the County of Bastrop, we the undersigned have read and fully agree and become a party to the full implementation of this program.

PASSED AND ADOPTED at a regular meeting of the COMMISSIONERS' COURT of the County held on the 22nd day of June 2015.

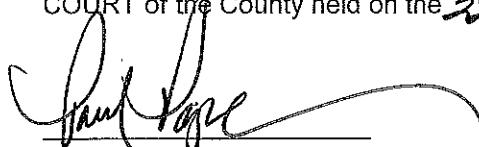
Paul Pape, County Judge

ATTEST:

Rose Pietsch, County Clerk